

# PROXIMITY SERIES:

# InfiniGage™

## The Gaging Lens

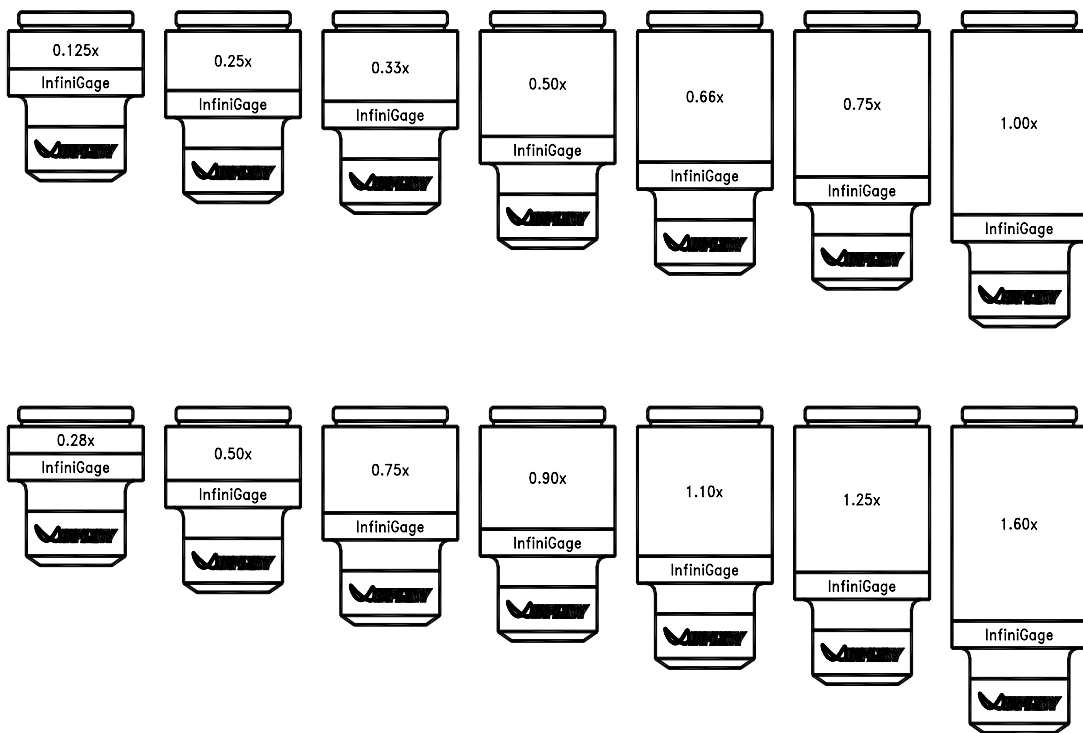

**INFINITY Photo-Optical Company** • *Manufacturers of precision optical instruments.*

2530 Frontier Ave., Boulder, CO 80301 • Tel: (303) 440-4544 • Fax: (303) 440-4144 • E-mail: [info@infinity-usa.com](mailto:info@infinity-usa.com) • Web: [www.infinity-usa.com](http://www.infinity-usa.com)

Copyright 2009 Infinity Photo-Optical Company. All Rights Reserved.

## INFINIGAGE OPTICAL FORMAT DATA

InfiniGage		0.125x	0.25x	0.33x	0.50x	0.66x	0.75x	1.00x
	WD mm	286	155	120	85	72	67	52
	Mag	0.125	0.25	0.33	0.50	0.66	0.75	1.00
	FOV 1/2"	51.2	25.6	19.4	12.8	9.7	8.5	6.4
	FOV 1/3"	38.4	19.2	14.5	9.6	7.3	6.4	4.8
<b>2x Amplifier</b>	WD mm	286	155	120	85	72	67	52
	Mag	0.25	0.50	0.66	1.00	1.32	1.50	2.00
	FOV 1/2"	25.6	12.8	9.7	6.4	4.8	4.3	3.2
	FOV 1/3"	19.2	9.6	7.3	4.8	3.6	3.2	2.4

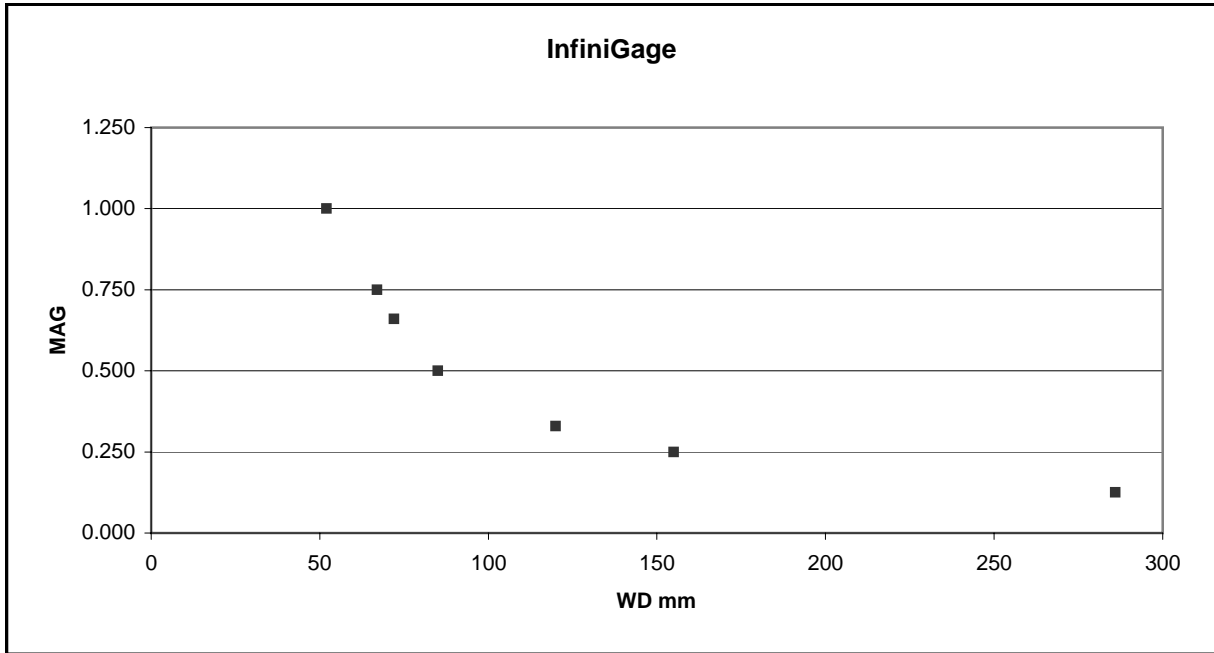

## INFINIGAGE OPTICAL RESOLUTION DATA AT 550nm

InfiniGage		0.125x	0.25x	0.33x	0.50x	0.66x	0.75x	1.00x
	<b>WD mm</b>	286	155	120	85	72	67	52
	<b>Mag</b>	0.125	0.25	0.33	0.50	0.66	0.75	1.00
	<b>NA</b>	0.007	0.012	0.016	0.022	0.026	0.028	0.037
	<b>Resolution (lines/mm)</b>	20	37	48	67	79	85	110
	<b>DOF mm</b>	12.5	3.7	2.2	1.1	0.8	0.7	0.4

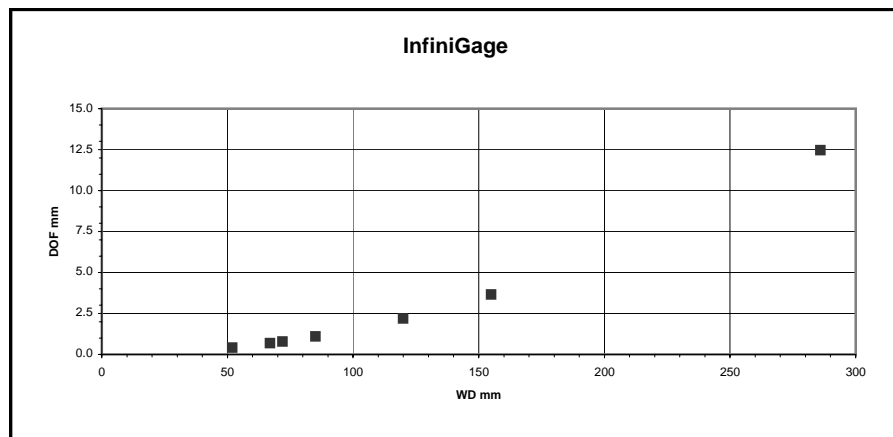
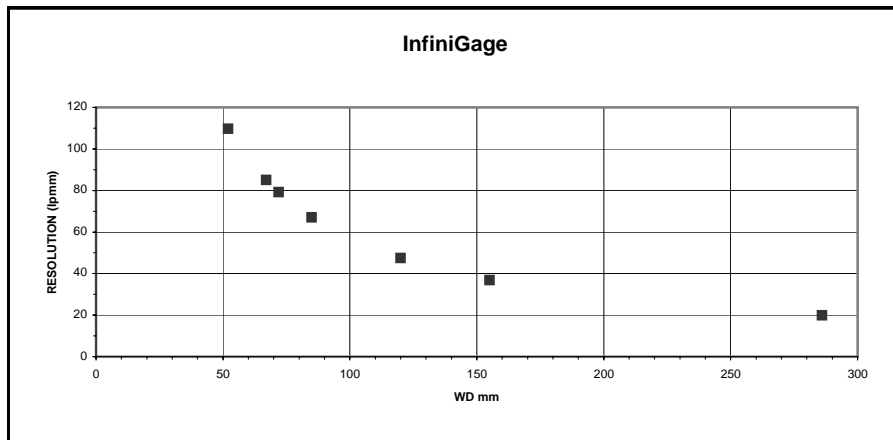
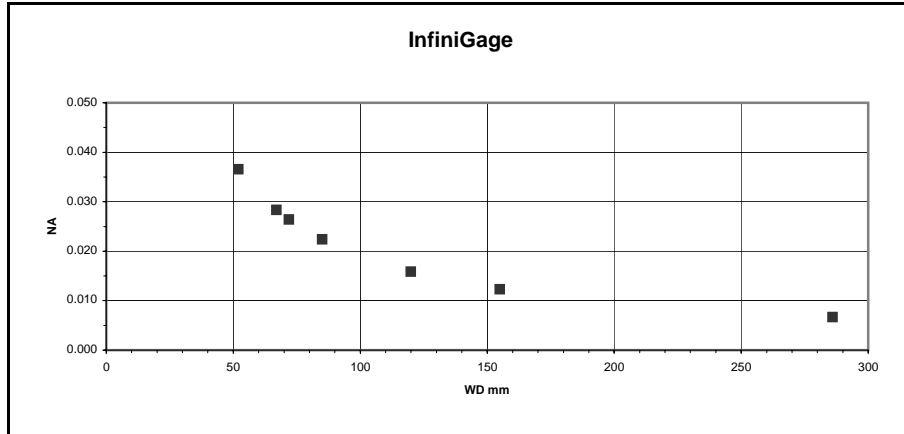

## INFINIGAGE UV OPTICAL RESOLUTION DATA AT 340nm

InfiniGage UV		0.125x	0.25x	0.33x	0.50x	0.66x	0.75x	1.00x
	<b>WD mm</b>	286	155	120	85	72	67	52
	<b>Mag</b>	0.125	0.25	0.33	0.50	0.66	0.75	1.00
	<b>NA</b>	0.007	0.012	0.016	0.022	0.026	0.028	0.037
	<b>Resolution (lines/mm)</b>	32	59	77	108	128	138	177
	<b>DOF mm</b>	7.7	2.3	1.4	0.7	0.5	0.4	0.3

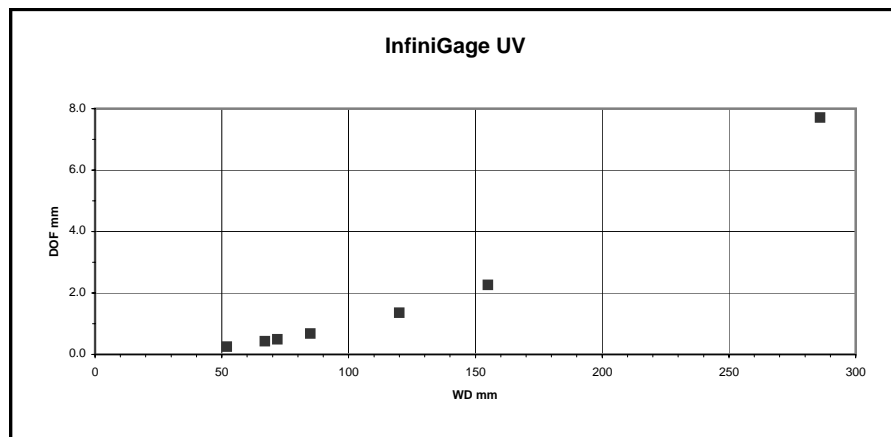
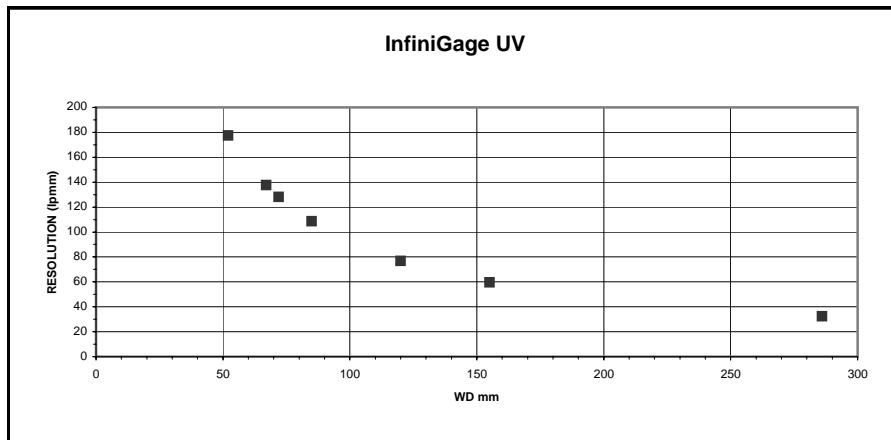
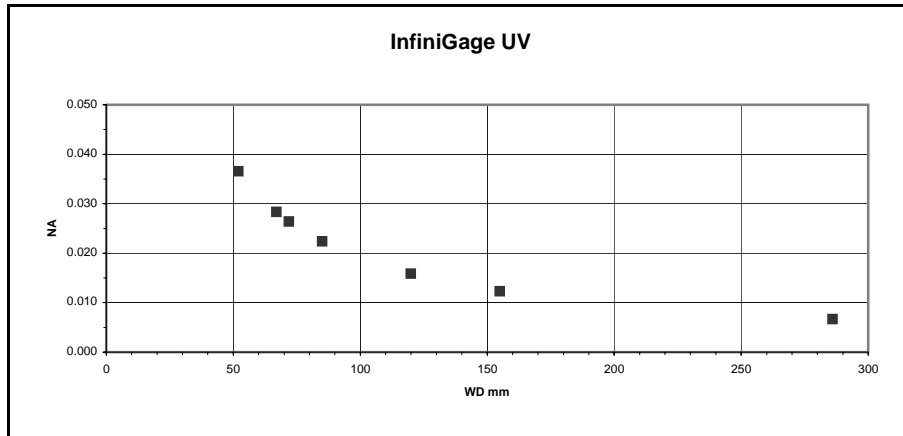

## INFINIGAGE CW OPTICAL FORMAT DATA

InfiniGage		0.28x	0.50x	0.75x	0.90x	1.10x	1.25x	1.60x
	WD mm	95	56	39	34	29	26	23
	Mag	0.280	0.50	0.75	0.90	1.10	1.25	1.60
	FOV 1/2"	22.9	12.8	8.5	7.1	5.8	5.1	4.0
	FOV 1/3"	17.1	9.6	6.4	5.3	4.4	3.8	3.0
<b>2x Amplifier</b>	WD mm	95	56	39	34	29	26	23
	Mag	0.56	1.00	1.50	1.80	2.20	2.50	3.20
	FOV 1/2"	11.4	6.4	4.3	3.6	2.9	2.6	2.0
	FOV 1/3"	8.6	4.8	3.2	2.7	2.2	1.9	1.5

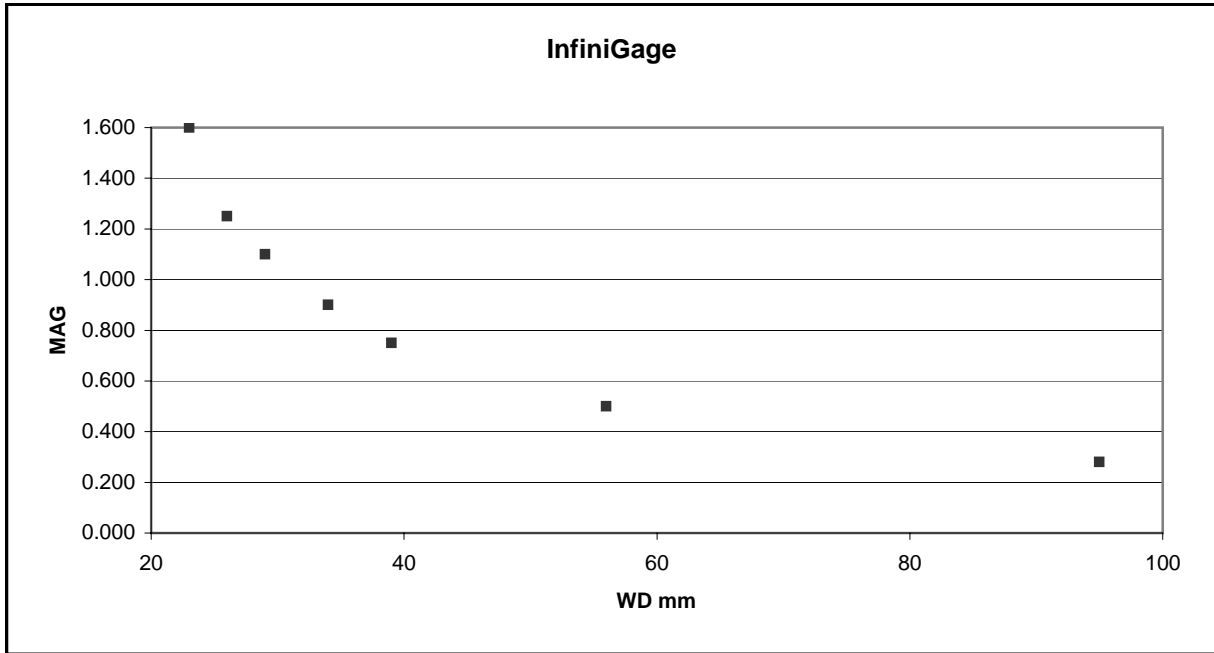

## INFINIGAGE CW OPTICAL RESOLUTION DATA AT 550nm

InfiniGage CW		0.28x	0.5x	0.75x	0.90x	1.1x	1.25x	1.60x
	<b>WD mm</b>	95	56	39	34	29	26	23
	<b>Mag</b>	0.28	0.50	0.75	0.90	1.10	1.25	1.60
	<b>NA</b>	0.017	0.029	0.041	0.047	0.055	0.062	0.070
	<b>Resolution (lines/mm)</b>	51	86	123	141	166	185	209
	<b>DOF mm</b>	1.94	0.67	0.33	0.25	0.18	0.14	0.11

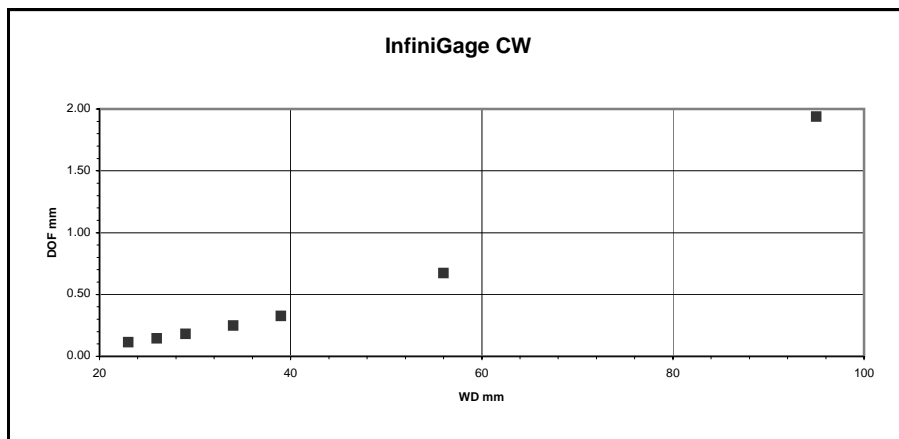
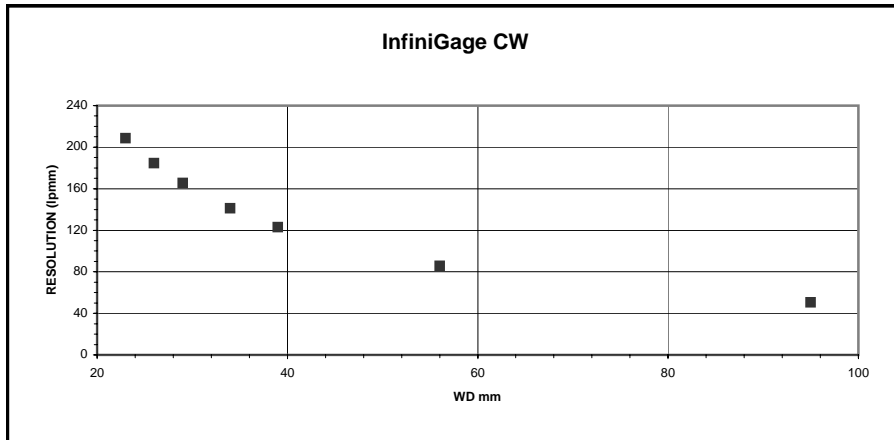
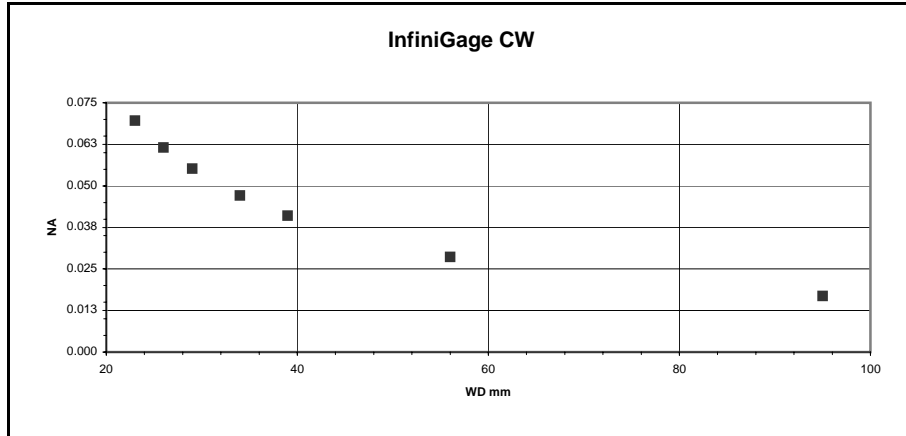

REVISIONS				
ZONE	REV	DESCRIPTION	DATE	APPROVED

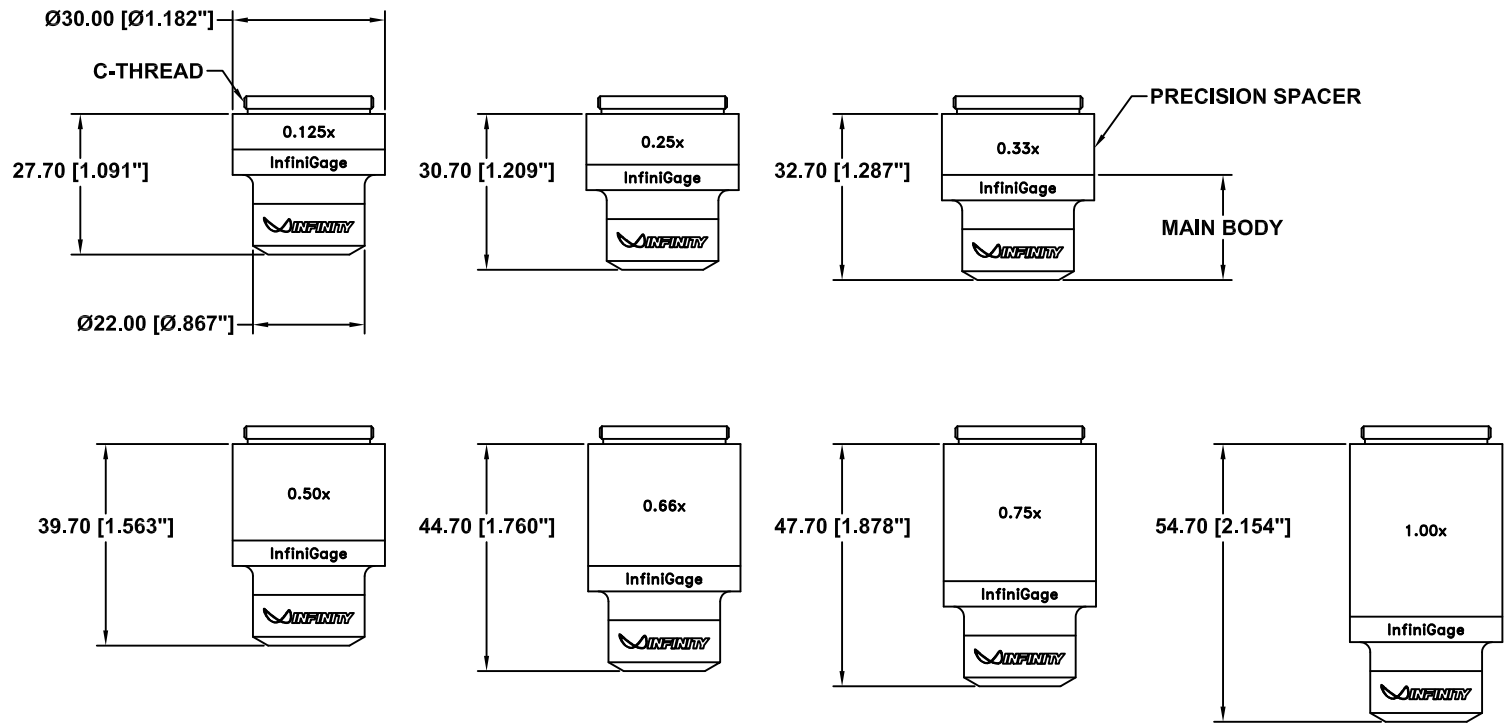

This drawing is for informational purposes only. No other rights or privileges are granted or implied.

ALL DIM ARE mm [inches] AND ARE FOR REFERENCE ONLY AND ARE SUBJECT TO CHANGE.

**INFINITY** Photo-Optical Company  
www.infinity-usa.com

**INFINIGAGE MAIN LENS BODY AND PRECISION SPACERS**

Date: 10/05/04 MB	SIZE B	FSCM NO.	DWG NO. -	REV -
Modified:	SCALE NONE	-	SHEET 1 OF 1	

REVISIONS				
ZONE	REV	DESCRIPTION	DATE	APPROVED

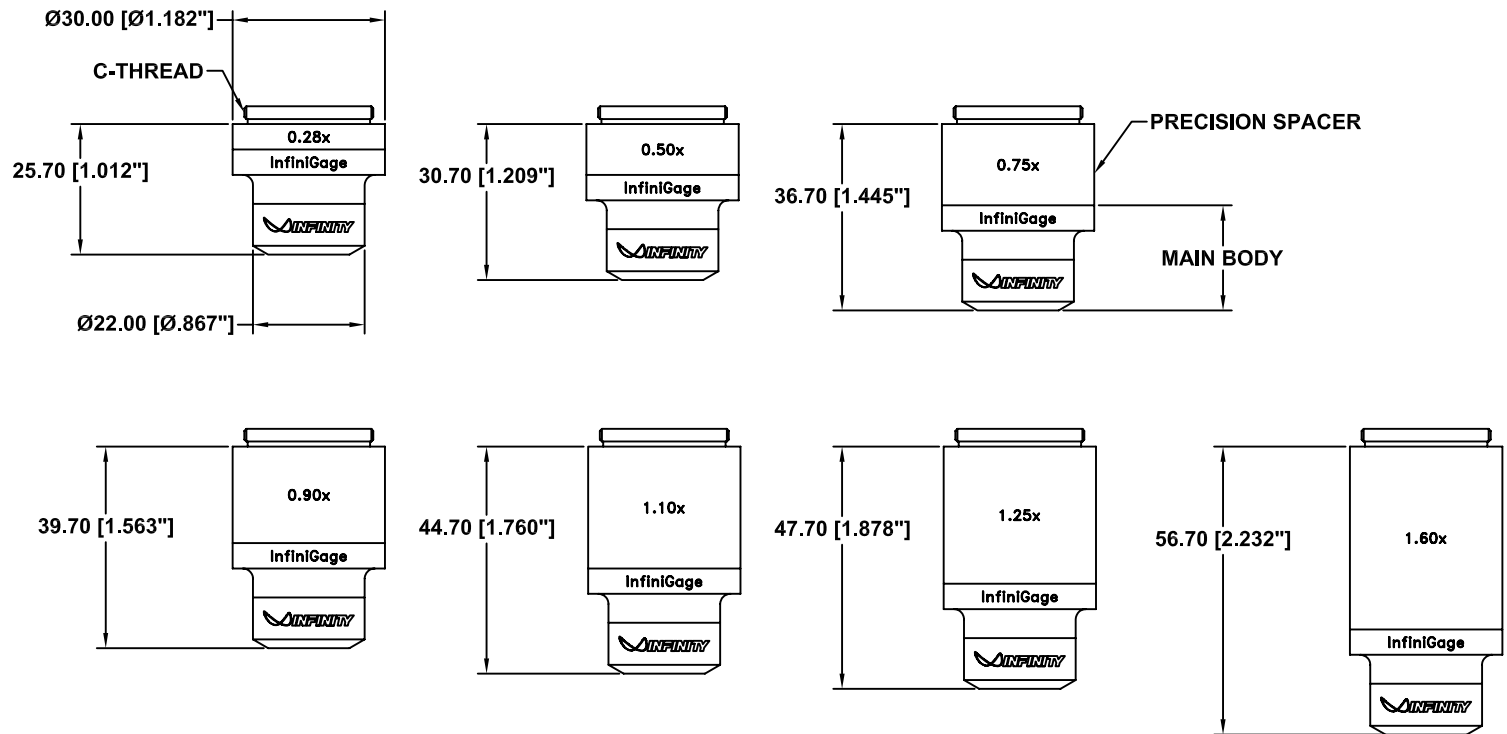

This drawing is for informational purposes only. No other rights or privileges are granted or implied.

ALL DIM ARE mm [inches] AND ARE FOR REFERENCE ONLY AND ARE SUBJECT TO CHANGE.		 <b>INFINITY</b> Photo-Optical Company 2530 Frontier Ave., Boulder, CO 80301 303/440-4544 Fax 303/440-4144			
Date: 05/13/09 MB		SIZE <b>B</b>	FSCM NO.	DWG NO. -	REV -
Modified:		SCALE <b>NONE</b>	-	SHEET <b>1 OF 1</b>	
<b>INFINIGAGE CW MAIN LENS BODY AND PRECISION SPACERS</b>					



This drawing is for informational purposes only.  
No other rights or privileges are granted or implied.

REVISIONS				
ZONE	REV	DESCRIPTION	DATE	APPROVED

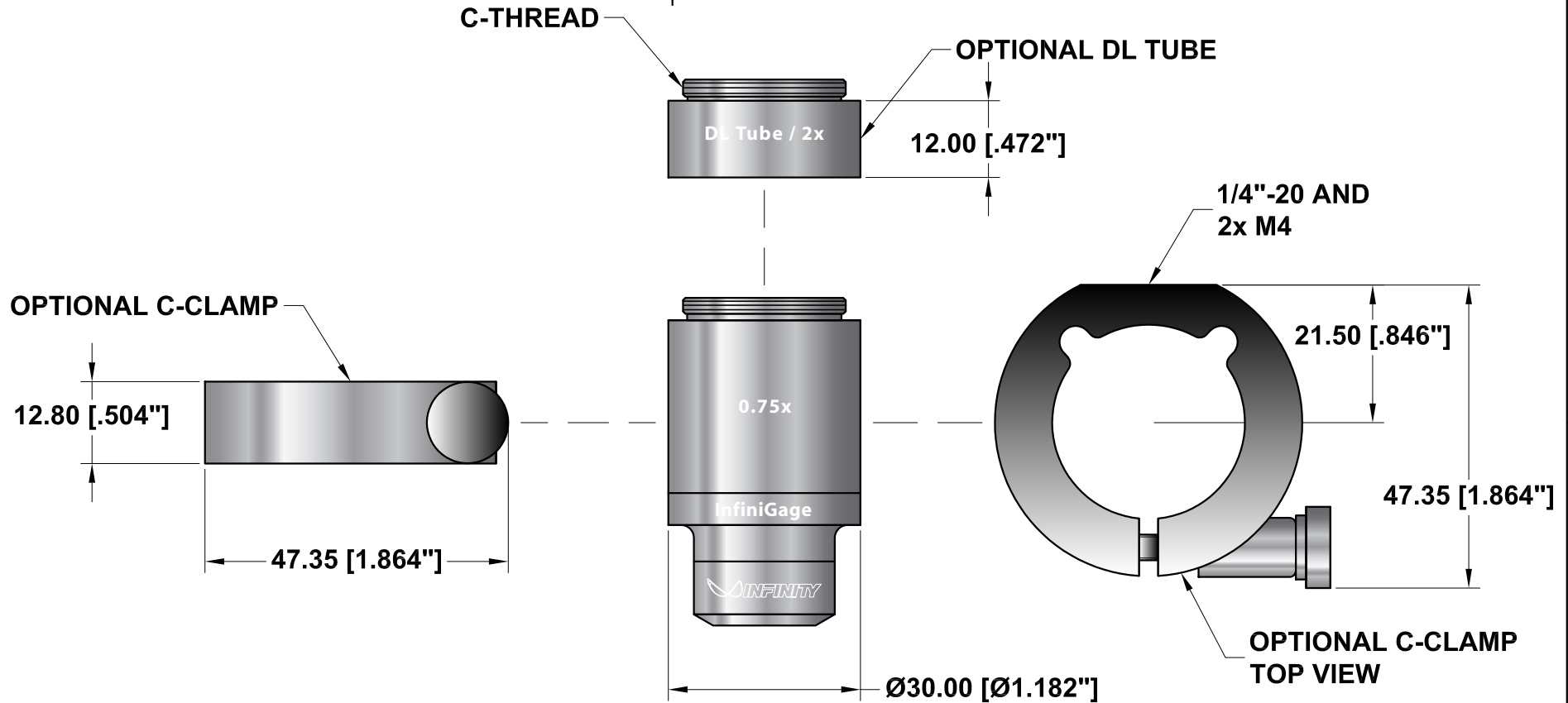

ALL DIM ARE mm  
[inches] AND ARE FOR  
REFERENCE ONLY AND  
ARE SUBJECT TO  
CHANGE.

**INFINITY** Photo-Optical Company  
2530 Frontier Ave., Boulder, CO 80301  
303/440-4544 Fax 303/440-4144

**INFINIGAGE OPTIONS**

<b>Date: 10/05/04 MB</b>	SIZE A	FSCM NO.	DWG NO. -	REV -
<b>Modified:</b>	SCALE NONE	-	SHEET 1 OF 1	

This drawing is for informational purposes only.  
 No other rights or privileges are granted or implied.

REVISIONS				
ZONE	REV	DESCRIPTION	DATE	APPROVED

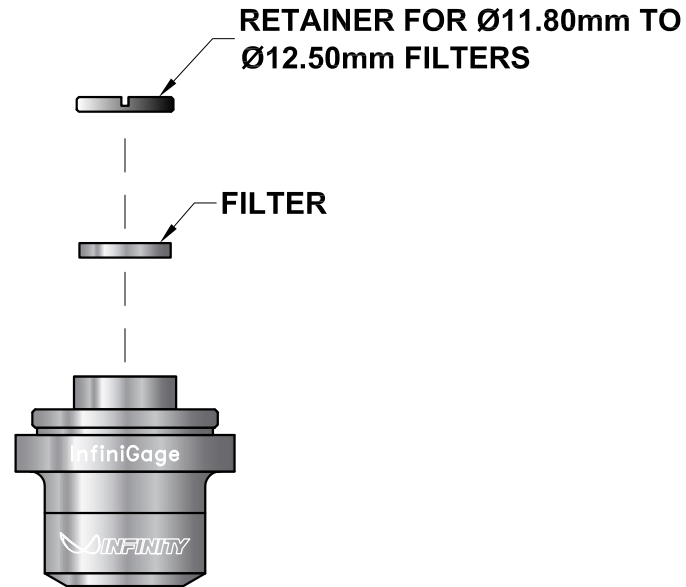

**ALL DIM ARE mm  
 [inches] AND ARE FOR  
 REFERENCE ONLY AND  
 ARE SUBJECT TO  
 CHANGE.**

**INFINITY** Photo-Optical Company  
 2530 Frontier Ave., Boulder, CO 80301  
 303/440-4544 Fax 303/440-4144

**INFINIGAGE FILTER INSTALLATION**

Date: 10/05/04 MB

SIZE A	FSCM NO.	DWG NO.	REV
		-	-

Modified:

SCALE	NONE	-	SHEET 1 OF 1
-------	------	---	--------------

## **INFINITY PHOTO-OPTICAL COMPANY LIMITED WARRANTY**

INFINITY PHOTO-OPTICAL COMPANY hereby warrants its products to be free from defects in workmanship or materials for the warranty period set forth below. INFINITY PHOTO-OPTICAL COMPANY, at its option, shall repair or replace the defective product without cost to the purchaser, and such repair or replacement shall be the full extent of this express limited warranty. INFINITY PHOTO-OPTICAL COMPANY shall not be liable for any other damages either direct or consequential.

This warranty is made to the original purchaser, and is effective only on new equipment purchased from INFINITY PHOTO-OPTICAL COMPANY, or a dealer authorized by INFINITY PHOTO-OPTICAL COMPANY to sell the product.

This warranty is valid only when the product is returned to the authorized dealer from whom it was purchased, or returned directly to INFINITY PHOTO-OPTICAL COMPANY, freight prepaid, with proof of date of purchase.

This warranty does not extend to any defect, malfunction or failure caused by misuse, abuse or the use of the product with equipment for which it may not have been intended. Any unauthorized repair voids this warranty.

The warranty period for all products manufactured by INFINITY PHOTO-OPTICAL COMPANY is five (5) years from date of original purchase. Parts or components made or sourced from other manufacturers shall be solely covered by that manufacturer's warranty.

The warranty contained herein is the only warranty made by INFINITY PHOTO-OPTICAL COMPANY. Any implied warranty of merchantability and/or fitness for a particular purpose is expressly excluded from this warranty. INFINITY PHOTO-OPTICAL COMPANY shall not be liable for any expense, loss, incidental or consequential damages which may arise in connection with the use of this equipment. Recovery under this warranty is limited to repair or replacement of the equipment as provided above.

INFINITY PHOTO-OPTICAL COMPANY reserves the right to modify designs, equipment and accessories without notice.